



# CHEFTOP MIND.Maps™ PLUS



# Index

CHEFTOP MIND.Maps™ PLUS combi-steamers	page	<b>4</b>
Cooking Assistance	page	<b>8</b>
Technologies	page	<b>12</b>
PLUS capacitive control panel	page	<b>24</b>
CHEFTOP MIND.Maps™ PLUS COUNTERTOP	page	<b>30</b>
CHEFTOP MIND.Maps™ PLUS COMPACT	page	<b>42</b>
CHEFTOP MIND.Maps™ PLUS BIG	page	<b>48</b>
CHEFTOP MIND.Maps™ PLUS BIG COMPACT	page	<b>54</b>
Cooking Essentials Special Trays	page	<b>60</b>
Care and Maintenance	page	<b>68</b>
Technical data	page	<b>74</b>
Technical Assistance	page	<b>84</b>
Unox in the world	page	<b>86</b>

# Intelligent combi ovens

CHEFTOP MIND.Maps™ PLUS is the intelligent combi oven that grills, fries, roasts, browns, smokes, cooks with steam and much more. Automatic cooking cycles and smart functions, including Artificial Intelligence, make CHEFTOP MIND.Maps™ PLUS the ideal partner for your kitchen, providing concrete support to your work. CHEFTOP MIND.Maps™ PLUS is designed to meet every need of your business and enable you to improve your kitchen processes.

MIND.Maps™ PLUS combi ovens are available in four versions, to meet the specific needs of each business:

**COUNTERTOP** 3, 5, 7 and 10 GN 1/1 and 6, 10 GN 2/1 for restaurants and deli shops;

**COMPACT** 5 and 10 GN 1/1 and 5 GN 2/3 for professional kitchens with small spaces and small shops;

**BIG** 20 GN 1/1 and 20 GN 2/1 trolley units for contract feeders, hotels and banqueting facilities;

**BIG COMPACT** 20 GN 1/1 trolley units for contract feeders, hotels and banqueting facilities.

Oven range



CHEFTOP MIND.Maps™ PLUS  
COMPACT



CHEFTOP MIND.Maps™ PLUS  
COUNTERTOP



CHEFTOP MIND.Maps™ PLUS  
BIG



CHEFTOP MIND.Maps™ PLUS  
BIG COMPACT

Oven range



A photograph of two men in white chef uniforms standing outdoors in a garden. The man on the left is looking towards the camera, while the man on the right has his hands on his hips and is looking slightly to the side. Both uniforms have a red floral logo and the name 'Sandro' or 'Maurizio' embroidered on the chest. The background is a lush garden with greenery and a building in the distance.

Designed by your desires

## Services

Our promise is your guarantee of solid performance. Stay focused on your goals knowing that we are always by your side.



Individual Cooking Experience

# Try the oven for free. It's on us.



**01**

Book

Choose when and where to try your next Unox oven. Call our customer service and set up an appointment at your convenience.

Set up an appointment, call us or book it online on [unox.com](https://www.unox.com)



**02**

Cook with us

In your kitchen, with your ingredients and your recipes: a Unox Chef will make you experience all the benefits of the ovens' technologies.



**03**

Choose

Being sure of the results you can achieve, take the time you need to make a choice based on solid certainties.







# Cooking Assistance

TOP.Training

## Discover your oven



Learn, use, improve

Top.Training is the Unox free training service. Our Chefs will show you everything you need to get the best from your new oven, from its basic features to its most advanced technologies.

Download the **Top.Training** app from Google Play or App Store

Data Driven Cooking Community

## Inspire and be inspired



A world of Recipes for your ovens

Let yourself be inspired by the DDC.App cookbook: download the recipes prepared by the Unox Chefs and by the DDC community users. Participate in the community and share your recipe!

Download **DDC.App** from Google Play or App Store

CHEF.Line

## You call, Unox answers



24/7

The Unox Chef Team is always at your disposal to give you practical advice on programs cooking methods and to suggest you new recipes: from the most traditional to the most innovative ones.

Call us  
International  
**+39 049 86 57 511**  
Oceania  
**+61 3 9876 0803**



Apple Store



Play Store

# Intelligent. Precise. Connected.

Unox Intelligent Performance

A set of intelligent technologies designed to maximize your output, improve your performance and give shape to your ambitions.

Unox Intensive Cooking

The most advanced technologies to guarantee perfect cooking, uniformity on every tray and maximum cooking intensity.

Data Driven Cooking

Artificial intelligence which allows you to monitor your oven usage and provides you with suggestions to use the ovens in a better way.

Anton Bodyashkin - Ugli Restaurant - Russia



Unox Intelligent Performance

# Improve your performances

Achieving identical results for each load requires control, intelligence and expertise: exactly what CHEFTOP MIND.Maps™ PLUS combi oven is made for.

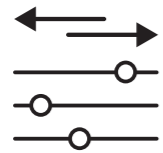

## ADAPTIVE.Cooking™

### Perfect results. Every time.

By registering changes in humidity and temperature, CHEFTOP MIND.Maps™ PLUS combi oven automatically adjusts the cooking process to the actual food-load to deliver an identical and perfect result every time.

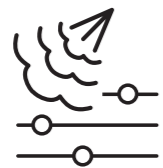

## CLIMALUX™

### Total humidity control.

The oven features accurate sensors to measure the actual humidity inside the cooking chamber and automatically activates steam production or evacuation to ensure that actual humidity always matches the set one.

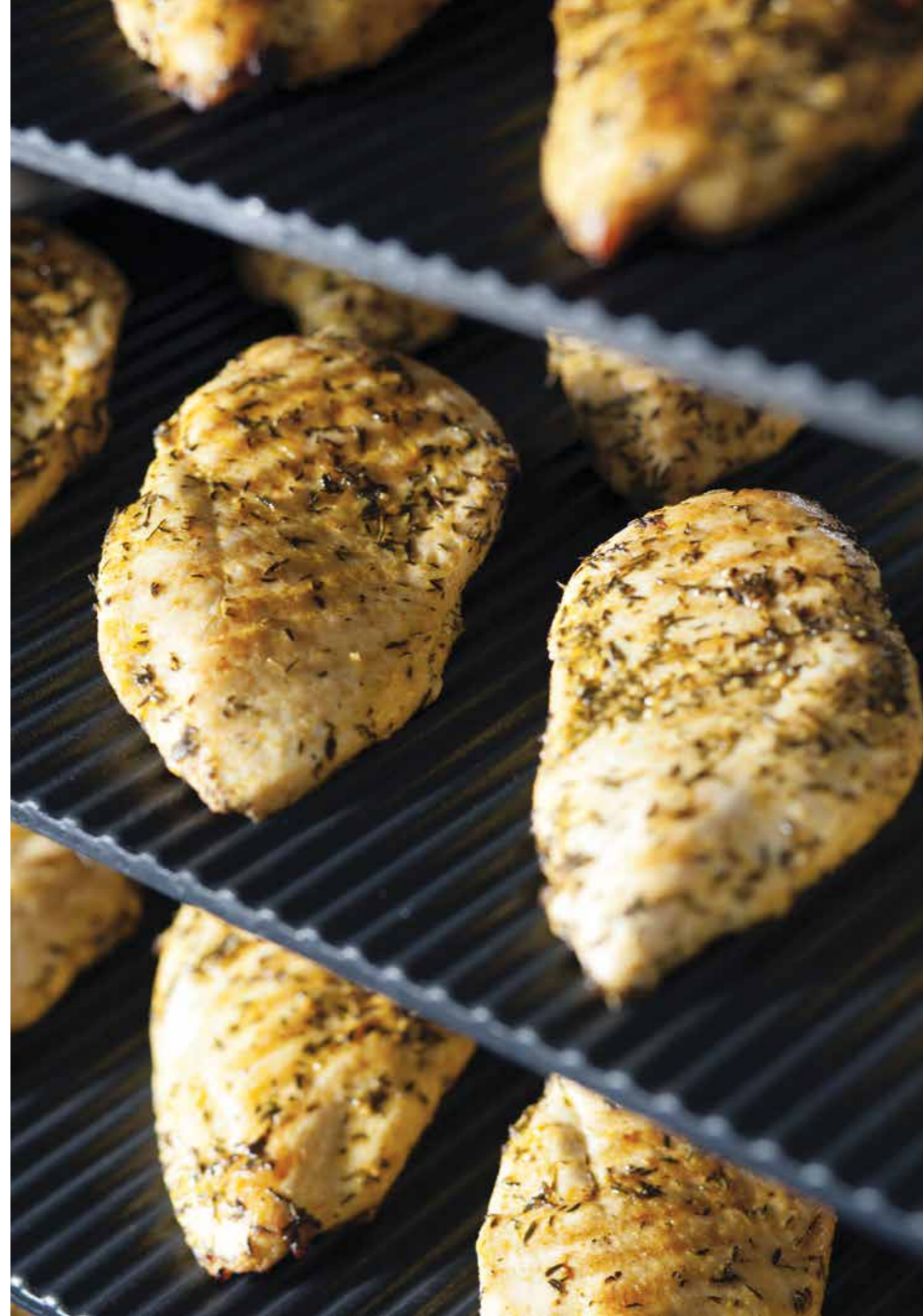

## SMART.Preheating

### Intelligent preheating.

Combining the analysis of previous cooking processes with the requirements of the next one, the oven automatically sets the best temperature and preheating time to guarantee maximum repeatability of results throughout the day, therefore reducing waiting time.



## AUTO.Soft

### Gentle cooking function.

When activated, the oven automatically regulates the rise in temperature to make it gentler and guarantee an optimal heat distribution on each pan in the oven. The best for delicate and heat-sensitive foods.



## SENSE.Clean

### Intelligent cleaning.

By estimating the degree of dirtiness, based on the type of cooking recognised by the oven, it suggests the best automatic cleaning mode according to the actual use of the oven. Maximum hygiene and zero waste of water and detergent.



# With

## Adaptive.Cooking™

It sets automatically all cooking parameters to guarantee the same result for every process.

**\*  
Optimal settings  
for a half load -  
30 portions**

🕒 6 mins

🌡️ 240 °C

💧 0%

Half load setting used with a single tray or with a full load.

# Without

Single tray - 6 portions



### Perfectly grilled

Browned outside  
Soft inside

Time  
5 mins  
Average temperature  
240 °C  
Humidity  
0 %



### Too much heating

Burned outside  
Dry inside

Time  
6 min  
Average temperature  
250 °C  
Humidity  
0 %

Full load - 60 portions



### Perfectly grilled

Browned outside  
Soft inside

Time  
8 mins  
Average temperature  
240 °C  
Humidity  
0 %



### Not grilled

Boiled effect  
Raw inside

Time  
6 min  
Average temperature  
220 °C  
Humidity  
50 %

# With

## CLIMALUX™

Measures the actual humidity in the cooking chamber and produces or extracts the quantity of humidity needed to obtain the set one.

**\*  
Optimal settings  
for a half load -  
16 chickens**

🕒 38 mins

🌡️ 190 °C

💧 30%

Half load setting used with a single tray or with a full load.

# Without

Single tray - 8 chickens



### Perfect roasting

Crispy skin  
Juicy meat  
Minimum weight loss

Humidity  
30 %



### Burned

Too brown  
Stringy meat  
Weight loss >35 %

Humidity  
20 %

Full load - 24 chickens



### Perfect roasting

Crispy skin  
Juicy meat  
Minimum weight loss

Humidity  
30 %



### Pale roast

Boiled effect outside  
Raw meat  
Pale colour

Humidity  
80 %



# With

## Auto.Soft

It manages the rise in temperature and maintains uniformity in every point of the tray, in each tray.

\*

### Optimal settings for a half load

🕒 10 mins 20 mins

🌡️ 100 °C 190 °C

🔥 100% -100%

Half load setting used with a single tray or with a full load.

### Single tray



#### Perfect browning

Soft inside  
Uniform texture  
Not burned

Rise time 100 - 190 °C  
7 mins



#### Burned outside

Burned edges  
Uneven baking  
Less cooked inside

Rise time 100 - 190 °C  
1 min

### Full load



#### Perfect browning

Soft inside  
Uniform texture  
Not burned

Rise time 100 - 190 °C  
7 mins



#### Burned outside

Burned edges  
Uneven baking  
Less cooked inside

Rise time 100 - 190 °C  
3 mins

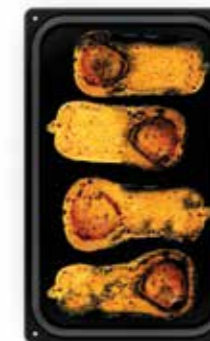

# With

## SMART.Preheating

The Intelligence automatically regulates duration and intensity of preheating: intense when the oven is cold, fast or even skipped when the oven is already hot.

\*

### Optimal settings for a half load

PRE 210 °C

🕒 18 mins

🌡️ 180 °C

Half load setting used with a single tray or with a full load.

### Single tray

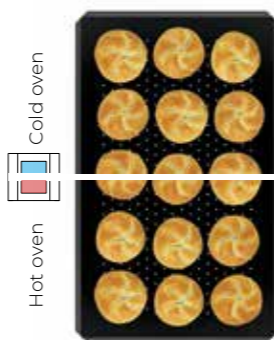

#### Perfect browning

Golden external colour

Preheating time  
9 mins  
Temp. oven chamber steel  
180 °C



#### Perfect browning

Golden external colour

Preheating time  
20 sec  
Temp. oven chamber steel  
180 °C

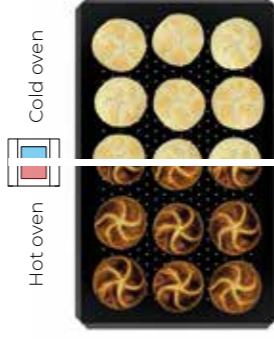

#### Pale browning

Pale external colour

Preheating time  
6 mins  
Temp. oven chamber steel  
100 °C



#### Extreme browning

Burned crust

Preheating time  
6 mins  
Temp. oven chamber steel  
190 °C

### Full load

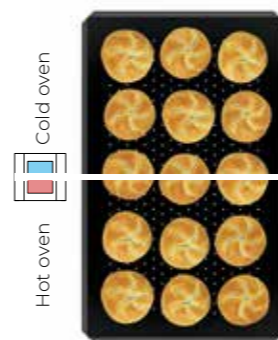

#### Perfect browning

Golden external colour

Preheating time  
9 mins  
Temp. oven chamber steel  
180 °C



#### Perfect browning

Golden external colour

Preheating time  
20 sec  
Temp. oven chamber steel  
180 °C

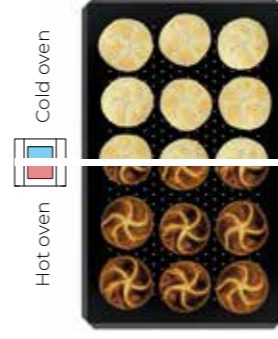

#### Pale browning

Pale external colour

Preheating time  
6 mins  
Temp. oven chamber steel  
100 °C



#### Extreme browning

Burned crust

Preheating time  
6 mins  
Temp. oven chamber steel  
190 °C



Unox Intensive Cooking

# Maximum cooking intensity

Perfect cooking, uniformity on each tray, saturated and dense steam or complete extraction of humidity, intense or gentle air flows.

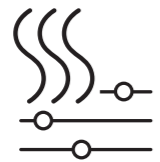

**DRY.Maxi™**

**Humidity gives way to flavour.**  
Effectively removes humidity from the cooking chamber to give your preparations perfect consistency, colour and crunchiness every time.



**STEAM.Maxi™**

**The power of steam is in your hands.**  
Generates saturated steam from 35 °C and delivers high steaming performance combined with energy and water savings.

- 6 minutes**  
full load  
of **crunchy bacon**
- 8 minutes**  
full load  
of **grilled pork chops**
- 24 minutes**  
full load  
of **steamed rice**
- 24 minutes**  
full load  
of **steamed potatoes**
- 39 minutes**  
full load  
of **roasted chickens (1,3 kg)**

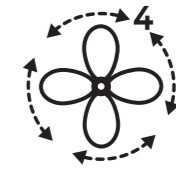

**AIR.Maxi™**

**Conducts, unites, transforms.**  
Uses multiple high flow reversing fans to deliver uniform results and short cooking times. 4 speeds of the fan allow to perform any kind of cooking.



**EFFICIENT.Power**

**Power and efficiency.**  
Quick temperature rise, high-precision temperature control, ENERGY STAR certified efficiency at the top of the category in combi, dry air and steam modes.



**PRESSURE.Steam**

**Even more steam when you need it.**  
Increases steam temperature and its saturation to effectively allow you to further reduce steaming time and its intensity.





Data Driven Cooking

**Create.  
Understand.  
Improve.**

The Data Driven Cooking Artificial Intelligence transforms the consumption data of your oven into useful information that allows you to increase your daily profit.

Data will be always accessible by smartphone or PC

# An ecosystem to be discovered

## Create and share



**Your recipes in all your ovens.**

Create your recipe book and synchronize it with all your ovens with just one click, keeping all your kitchens or stores up to date. You may create it directly from one of your ovens or from your PC.

## Understand



**Monitor and improve your performance.**

DDC.Stats gives you full control over energy, water, and detergent consumption and over your cooking times and oven usage. Compare the performances, detect anomalies and get useful information to improve the efficiency of the ovens in your network.

## 360° Assistance

**Let DDC.Coach train you.**

DDC.Coach is a digital assistant that provides you with advice based on the actual use of your ovens. This allows you to take full advantage of their potential. Capitalize the abilities of your ovens and maximize the return on your investment!



# Artificial intelligence in the kitchen



## Production Order Schedule

The artificial intelligence algorithm automatically plans the production based on the orders received.



## Planning next to the machine

The production plan is sent to Unox ovens making working in the kitchen easier.

## Flexible monitoring and planning

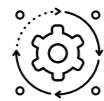

## Preparation And Cooking

The operator is guided by the information received on the control panel, that shows the work sequence and the quantities of food to be inserted into the oven.



## Immediate analysis of critical issues

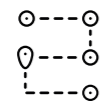

## Traceability and HACCP

All parameters of the executed processes and HACCP data are automatically saved on the cloud.



## Automatic and optimized schedule



## Order processing

When the cooking finishes, the information is made available immediately to prepare the shipment.

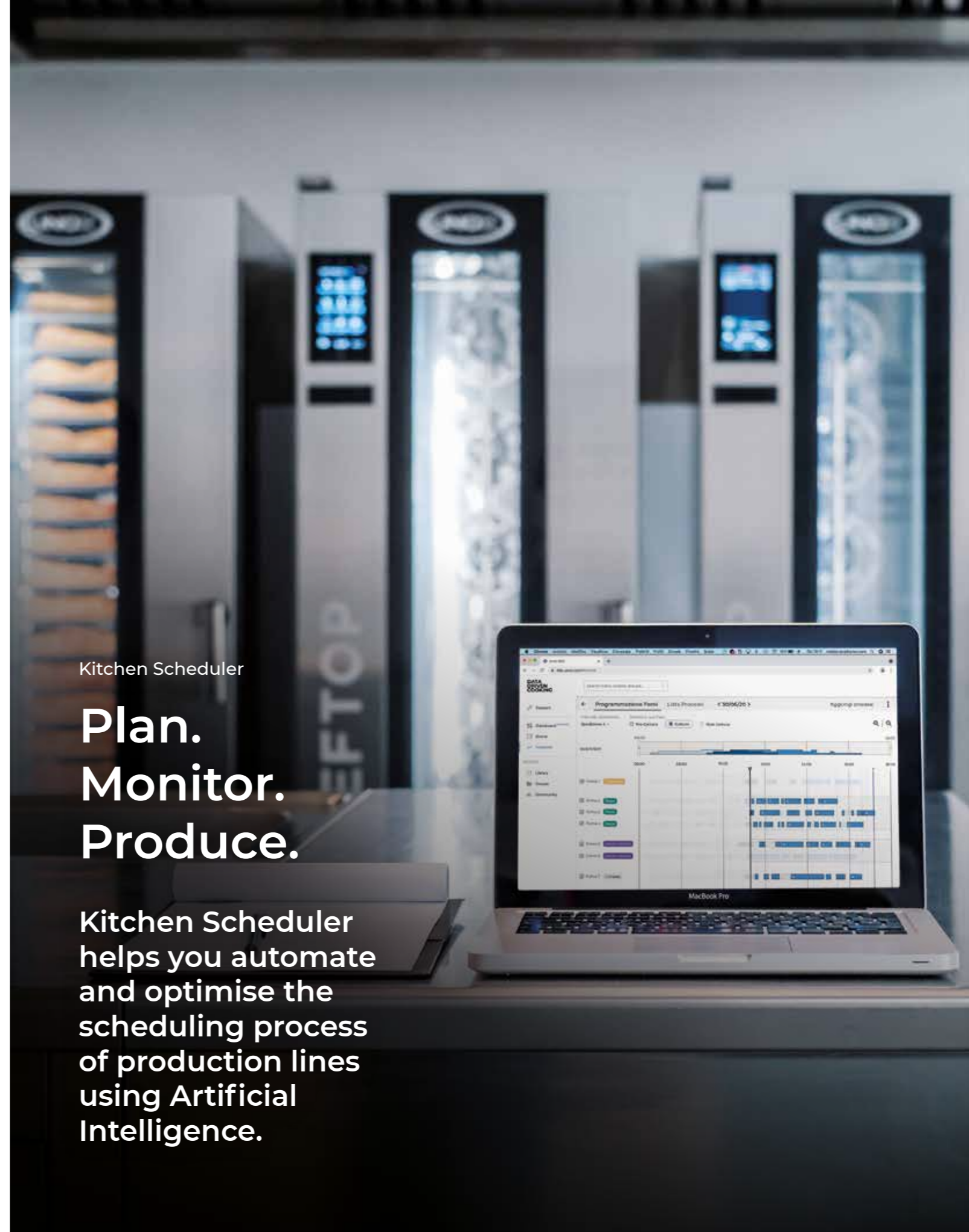

# Plan. Monitor. Produce.

Kitchen Scheduler helps you automate and optimise the scheduling process of production lines using Artificial Intelligence.



PLUS capacitive control panel

## Comprehensive and intuitive

Automatic cooking processes, manual functions, 384 programs memory and up to 10 simultaneous cooking. A large, readable touchscreen, that is fast and connected.





# Outdo yourself



## Set

### Easy, fast and crystal-clear.

Set any cooking process in a rapid and intuitive way for each of the available cooking steps. All the settings you need in a single screen, up to 9 cooking steps. Limitless creativity.



## MIND.Maps™

### Do not set a cooking process, draw it.

Add your touch of brilliance. Draw even the most elaborate cooking with a few hand gestures on the display. Design your most complex cooking processes with maximum creative freedom. You imagine, the oven executes.



## Programs

### 384 Programs memory.

All your recipes are unique and repeatable thanks to the personal library that allows you to store and organize your cooking programs. CHEFTOP MIND.Maps™ PLUS can store 384 programs organized in 16 different groups.



## MULTI.Time

### Up to 10 simultaneous cooking.

Ordered and organized. Manage up to 10 cooking processes at the same time with the MULTI.Time function and have the maximum control with a quick glance.



## CHEFUNOX

### Choose what you want to cook and the desired result.

Trust and allow your oven to set the cooking parameters for you. Select the type of cooking, the food you want to cook and the degree of cooking you want. Start. Nothing else.

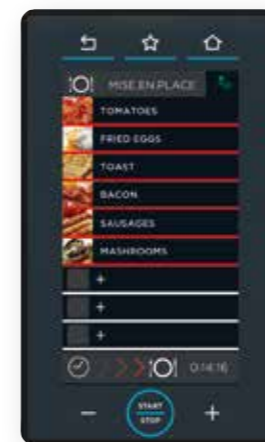

## MISE.EN.PLACE

### Beyond kitchen organization.

Suggests the correct order and timing for inserting trays inside the cooking chamber to have all the meals ready at the same time. Being punctual has never been so simple.





CHEFTOP MIND.Maps™ PLUS COUNTERTOP

## The most intelligent combi oven for Foodservice

CHEFTOP MIND.Maps™ **PLUS**  
COUNTERTOP is the combi  
oven of choice for those  
kitchens that need  
maximum performance,  
smart technologies  
and limitless versatility.



Dream big

# Express your creativity

CHEFTOP MIND.Maps™ PLUS COUNTERTOP is the professional oven that can help make your visions a reality. Cook every dish with the certainty of the maximum result. Every single time.

When combined with its accessories, your CHEFTOP MIND.Maps™ PLUS COUNTERTOP becomes a powerful cooking tool that replaces multiple pieces of traditional equipment in your kitchen.

Grilling, frying, roasting, browning, smoking, steaming and much more. Automatic cooking processes and intelligent functions give the guarantee of always impeccable results.

up to **45%**

**Less energy** compared to a traditional grill

up to **80%**

**Less water** compared to cooking in boiling water

Up to **90%**

**Less oil** compared to a fryer



**Cooking Perfection**  
Repeatable  
and consistent

**Versatility**  
Simultaneous cooking  
of multiple food items

**Saving**  
Energy, time,  
ingredients and labor

**Intelligence**  
Focus on your customers,  
the oven will do the rest

Versatile solutions for your individual needs

# Increase your Possibilities

Find all the possible solutions for your kitchen.  
[Configure](#) your CHEFTOP MIND.Maps™ PLUS oven online.

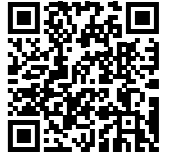

Configurations



## Oven + Neutral cabinet

Recommended solution to optimize your kitchen layout and always have everything in the right place.

Art. XWVEC-0811  
Technical details at page 82



## Oven + Oven

The solution with two stacked units is ideal for maximum versatility, flexibility and energy savings.



## Oven + Slowtop

Ideal solution for butchers and deli shops, that combine intense cooking processes with gentle ones, such as holding and night-time cooking.

Art. XEVSC-0711-CRM  
Discover more at page 38  
Technical details at page 81



## Oven + Stand

The multifunctional support ideal for storing trays safely and place your oven at the perfect height to work.

Art. XWVRC-0711-UH  
Technical details at page 82

Configurations

COUNTERTOP

COUNTERTOP



Zero smells in your kitchen

## Ventless Hood

Within the ventless hood, a self-cleaning filter **removes odours** from the fumes that are expelled through the oven chimney, without the need for maintenance or cleaning work on the filter. It allows you to install your oven even far from a ceiling canopy and force exhausts into it or outside.\*

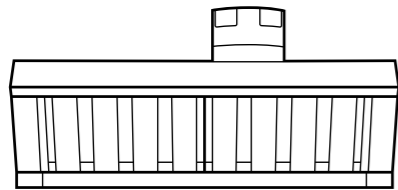

\*Subject to inspection and approval by organisations and to local regulations.



With activated carbon filter

## Ventless Hood

Features the self-cleaning filter **plus an activated carbon filter** that further removes smells, even those that are sucked when the door is opened at the end of a cooking cycle. It allows you to install your oven far from a ceiling canopy or without it.\*

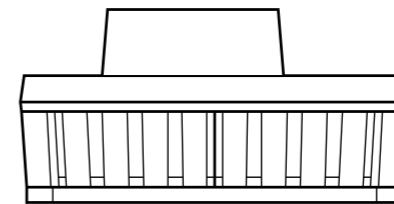

\*Subject to inspection and approval by organisations and to local regulations.

Slow cooking and Holding

## SLOWTOP

Low temperature cooking, slow braising, slow roasts, sous vide cooking, regeneration, holding, night cooking. Just some of the countless cooking techniques that SLOWTOP Cook'n'Hold offers. Thanks to its single-phase electrical power supply, it ensures unbeatable performances with **minimal consumption** and is the perfect partner for your oven.

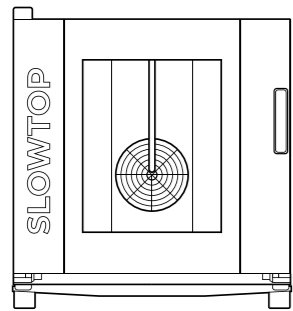

Smoke. Cook. Amaze.

## HYPER.Smoker

HYPER.Smoker transforms your oven into a smoker. You can use shavings of natural wood and choose from among **10 different smoking intensities** directly from the control panel of the oven to amaze even the most demanding of palates. Moreover you will smoke food using the energy produced in the cooking chamber without further costs and external electrical power supply.





SMART.Drain

# Cooking fat collection system

SMART.Drain is the ideal solution for supermarkets, deli shops, production kitchens and steak houses that carry out cookings with large amount of fat.

Its functioning is based on a special two-way valve that **collects any fat and cooking liquids** created during the cooking program and **drains them into a tank**.

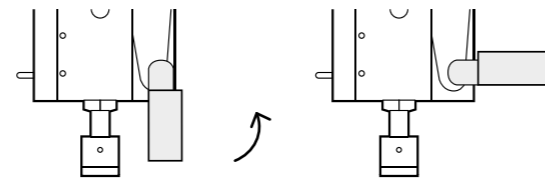

Liquid to tank  
(fat collection)

Liquid to drainage  
(washing and  
low-fat cooking)



For each one of your cooking or washing programs, **your oven automatically checks the correct position of the valve** to avoid any risk of the drain being blocked by condensed fat.

The special **POLLO.BLACK trays convey the fats towards the drain**, reducing by up to 80% the amount of fat deposits that accumulate in the cooking chamber compared to normal grills.

Complementary Accessories



### Trolley solution Trolley + Basket

Load and unload food safely and simply.

Art. XWVYC-0011 + XWVBC-0611  
Technical details at page 82



### Closed solution Cabinet + SMART.Drain

The tank is hidden within the cabinet.

Art. XWVEC-0811 + XUC020  
Technical details at page 83



### Open solution Stand + SMART.Drain

The tank is in the most easily accessible location.

Art. XWVRC-0011-H + XUC020  
Technical details at page 83



### Double stack solution Oven + Oven + SMART.Drain

Double-stack ovens with SMART.Drain for lower unit.

Art. XWVRC-0011-L-PO + XWVYC-0011-L-PO + XUC020  
Technical details at page 83

Complementary Accessories





CHEFTOP MIND.Maps™ PLUS COMPACT

## The compact combi oven for Foodservice

CHEFTOP MIND.Maps™  
**PLUS COMPACT** is the  
compact professional  
combi oven for those who  
always want the best  
even with limited  
available space.



Small spaces, big ambitions

# High performances in less than 1 m<sup>2</sup>

CHEFTOP MIND.Maps™ PLUS COMPACT is the ideal solution for professional kitchens requiring the least footprint and maximum performance.

The CHEFTOP MIND.Maps™ PLUS COMPACT ovens exploit the most advanced Unox technologies.

Grilling, frying, roasting, browning, smoking, steaming and much more. Versatility cooking that reaches its maximum expression in multi-chamber solutions that give free space for ever-changing menus.

## 24%

Less footprint compared to a non compact oven

## 72 kg

Maximum capacity  
2 x 2 combination \*

## 530 mm

One of the narrowest ovens in its category

\*Data refers to a 4 XECC-0513-EPRM ovens combination.



**Reduced footprint**  
Get the most from  
vertical spaces

**Flexibility**  
Stack 2 units to enable  
different cookings  
at the same time

**Savings**  
A smaller cooking  
chamber  
requires less energy

**Intelligence**  
Focus on your customers,  
the oven will do the rest

Solutions to maximize your working space

# Compact combinations

Find all the possible solutions for your kitchen.  
[Configure](#) your CHEFTOP MIND.Maps™ PLUS oven online.



Configurations

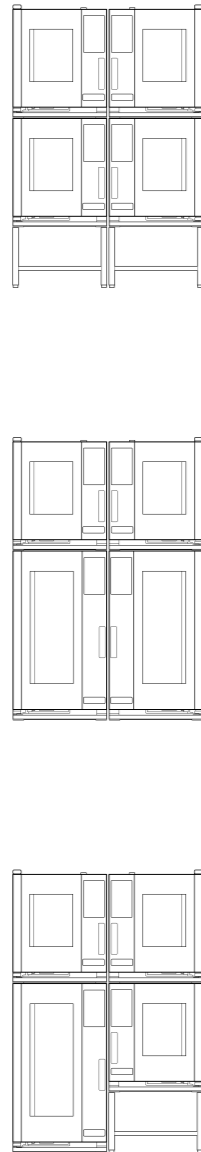

1 m

Configurations



## The benefits of 4 cooking chambers in the footprint of 2

A restaurant is made of variable rhythms; turn on just the ovens you need, reducing energy consumption, or turn all of them on for maximum flexibility.

## Oven + Stand

The multifunctional support ideal for storing trays safely and place your oven at the appropriate working height.

Art. XWCRC-0613-H  
Technical details at page 82





CHEFTOP MIND.Maps™ PLUS BIG

**Stronger  
Harder  
Faster  
Better**

The CHEFTOP MIND.Maps™ PLUS BIG trolley units are the tireless combi ovens for large kitchens that need maximum repeatability of cooking quality and high productivity.



What matters to you

# Limitless performances

CHEFTOP MIND.Maps™ PLUS BIG is the trolley combi oven with the highest productivity and reliability.

CHEFTOP MIND.Maps™ PLUS BIG uses the latest technologies to give concrete support to your work.

Steaming, grilling, regeneration of dishes and much more: maximum performance and perfectly optimized full loads.

Quality and cooking uniformity are always guaranteed with any foodload, and the repeatability of cooking is independent by its user.

## 180 kg

Full load maximum capacity

## 300 °C

Maximum cooking temperature

## 4.5 min

Preheating time from 30 °C to 300 °C

Data refer to XEVL-2021-YPRS model



**Productivity**  
High volumes,  
zero stops

**Uniformity**  
6 close-pitch  
reversing fans

**Repeatability**  
Standardized results,  
consistency

**Intelligence**  
Focus on your customers,  
the oven will do the rest



Solutions that maximise your return on investment

# Maximum Yield, minimum effort

CHEFTOP MIND.Maps™ BIG PLUS ovens offer you flawless cooking results in all load conditions thanks to 6 high-performance motors and fully saturated steam production in the cooking chamber.

Find all the possible solutions  
for your kitchen.  
[Configure](#) your  
CHEFTOP MIND.Maps™ PLUS oven online.



Solutions



2,8 m

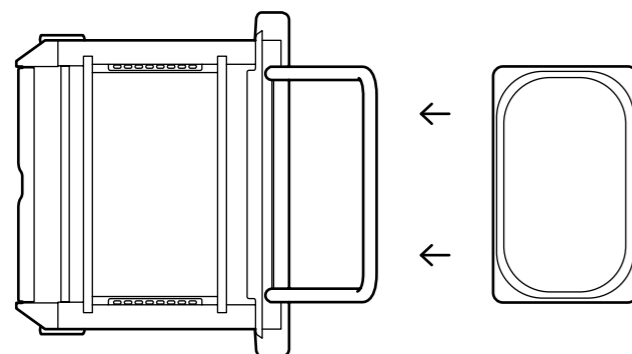

### Tray insertion from the long side

Better visibility of all the food  
in the oven, even when  
fully loaded.

Do you need a solution that is  
compatible with GN1/2 and GN1/3  
trays? Discover CHEFTOP MIND.Maps™  
BIG COMPACT at page 58



### QUICK.Load

20 GN2/1 or GN 1/1 trolleys  
for fast insertion in the oven  
and easy transport of full  
loads.

Art. XEVTL-2021  
Technical details at page 83



### QUICK.Plate

A trolley to regenerate up to  
102 plates in a few minutes.  
We are at your disposal to  
customize your QUICK.Plate  
based on your specific needs.

Art. XEVTL-102P  
Technical details at page 83



### HOLDING.Cover

Holding cover keeps  
the regenerated plates  
at the right temperature  
before serving.

Art. XUC031  
Technical details at page 83

Solutions



CHEFTOP MIND.Maps™ PLUS BIG COMPACT

## Compact outside, big inside

CHEFTOP MIND.Maps™  
**PLUS BIG COMPACT**  
professional trolley oven  
is the ideal tool for large  
kitchens and cooking  
centres, that need  
to maximise productivity  
and space.

CHEFTOP

CHEFTOP

CHEFTOP

CHEFTOP

UNOX

UNOX

UNOX

MIND Maps™

MIND Maps™



Small spaces, big productions

# Performance without space limits

CHEFTOP MIND.Maps™ PLUS BIG COMPACT is the professional smart trolley oven which allows you to maximise the productivity per square meter in your kitchen.

CHEFTOP MIND.Maps™ PLUS BIG COMPACT concentrates all Unox technologies in 650 mm width to give you maximum performance in minimum space.

Steaming, grilling, regeneration of dishes and much more: maximum performance via perfectly optimized full loads.

Quality and uniformity of cooking are always guaranteed with any food load, and the repeatability of cooking is independent by its user.

**90 kg**

Full load maximum **capacity**

**300 °C**

Maximum cooking **temperature**

**4.5 min**

Preheating **time** from 30 °C to 300 °C



**Reduced footprint**  
Maximum productivity in just 0,65 square metres

**Compatibility**  
The trolley is compatible with the majority of blast chillers

**Performance**  
High volumes, repeatable processes and uniform results

**Intelligence**  
Focus on your customers, the oven will do the rest

Solutions that maximise the productivity per square metre

# Small spaces, big productions

Find all the possible solutions for your kitchen.  
[Configure](#) your CHEFTOP MIND.Maps™ PLUS oven online.



The benefits of 4 ovens in the footprint of 3



2,8 m

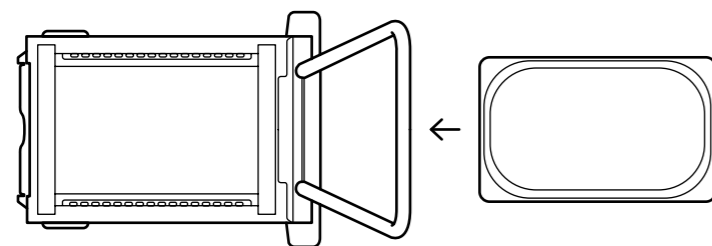

### Compatible with GN1/1, GN1/2 and GN1/3 trays

Compact design achieved by inserting the tray from the short side.

Do you need a solution with tray insertion from the long side?  
Discover CHEFTOP MIND.Maps™ BIG at page 52.

### QUICK.Load

20 GN 1/1 trolleys simplify cooking and transportation of large food quantities.

Art. XECTL-2013  
Technical details at page 83

### QUICK.Plate

A plate trolley to regenerate and transport up to 51 plates. We can customize the trolley based on your specific needs.

Art. XECTL-051P  
Technical details at page 83

### HOLDING.Cover

Holding cover keeps the regenerated plates at the right temperature before serving.

Art. XUC033  
Technical details at page 83





Cooking Essentials Trays

**Unlimited  
cooking  
modes**

Purpose-designed pans

# Cooking Essentials

## SUPER.GRILL

Non-stick aluminium pan plus grill with QUICK.Load system.



**Ideal for**  
Grilled meat;  
Grilled fish;  
Grilled vegetables.

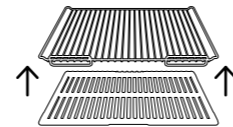

**Advantages**  
Perfect for full loads.  
Grilling times up to 30% less than traditional grill.

Art. TG970 GN 1/1 - Only for COUNTERTOP and BIG models.

## GRILL

Non-stick alluminum grilling pan. Does not require to be preheated before use.



**Ideal for**  
Grilled fish;  
Grilled vegetables.

**Advantages**  
Does not require to be preheated into the oven to achieve outstanding squared marks on food; Perfect for full loads.

Art. TG885 GN 1/1 - Art. TG720 GN 2/3

## FAKIRO.GRILL

Non-stick aluminium pan. Two cooking surfaces: ribbed for grilling, flat for different types of cooking.



**Ideal for**  
Grilled meat and fish;  
Grilled vegetables;  
Pizza and Focaccia.

**Advantages**  
Grilling times up to 30% less than traditional grilling equipment or fry tops;  
Grilling different types of food at the same time.

Art. TG870 GN 1/1 - Art. TG770 GN 2/3

## POLLO.GRILL

Stainless steel grid with fat-collection tray.



**Ideal for**  
Spatchcock or Split chicken;  
Roast meats;  
Roast fish.

**Advantages**  
Fat collection tray that keeps the oven clean;  
Works best in combination with SMART.DRAIN fat collection kit.

Art. GRP840 GN 1/1

## BACON.40

Stainless steel grid with fat-collection pan.



**Ideal for**  
Bacon;  
Roast meat;  
Spatchcock or Split chicken.

**Advantages**  
Up to 18 crispy bacon slices in less than 5 mins;  
The fat collection tray is coated with non-stick material for easy cleaning.

Art. TG945 GN 1/1

## POLLO.BLACK

8 chicken non-stick stainless steel grid.

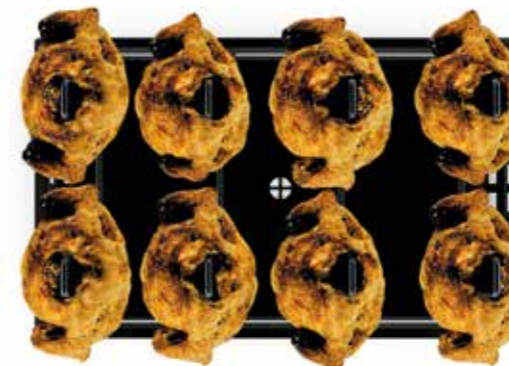

**Ideal for**  
Whole chickens and birds.

**Advantages**  
Non-stick coating to facilitate bird removal;  
Works best in combination with SMART.DRAIN fat collection kit.

Art. GRP825 GN 1/1 - Art. GRP715 GN 2/3



Purpose-designed pans

# Cooking Essentials

## BLACK.40

40 mm deep, non-stick aluminium pan.



### Ideal for

Braising;  
Roasting;  
Steaming rice.

### Advantages

Waste-free braising, roasting and rice steaming;  
The tray is coated with high-resistance, non-stick material for easy food removal and cleaning.

Art. TG900 GN 1/1

## BLACK.20

20mm non-stick stainless steel pan.



### Ideal for

Braising;  
Roasting;  
Steaming rice.

### Advantages

Waste-free braising, roasting and rice steaming;  
The tray is coated with high-resistance, non-stick material for easy food removal and cleaning.

Art. TG895 GN 1/1

## BLACK.FRY

Non-stick stainless steel frying pan.



### Ideal for

Pre-fried frozen food,  
French fries.

### Advantages

Perforated bottom and sides;  
Ribbed bottom to improve air circulation and uniformity on french fries.

Art. GRP816 GN 1/1

## CLEAN.FRY

Non-stick frying grid with fat collection tray.

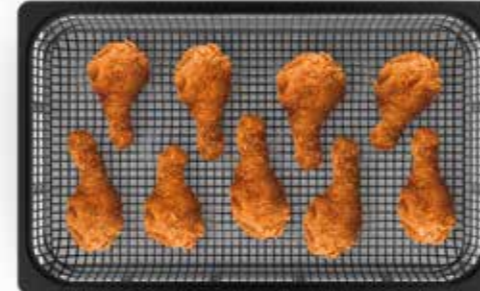

### Ideal for

Frozen pre-fried foods.

### Advantages

Frying pan with non-stick coated fat-collection pan for easy food removal and cleaning.

Art. GRP820 GN 1/1

## POTATO.FRY

French fries frying pan.



### Ideal for

French fries

### Advantages

Perforated bottom and sides;  
Ribbed bottom to improve air circulation on french fries.

Art. GRP817 GN 1/1

## PAN.FRY

Non-stick stainless steel frying pan.



### Ideal for

Nuggets;  
Breaded veggies;  
Fish and meat sticks.

### Advantages

Less oil to be used for cooking;  
Identical frying results on each piece of food.

Art. TG905 GN 1/1 - Art. TG735 GN 2/3

Purpose-designed pans

# Cooking Essentials

## EGGS 6 x 2

Non-stick alluminum pan for 6 double-egg portions.

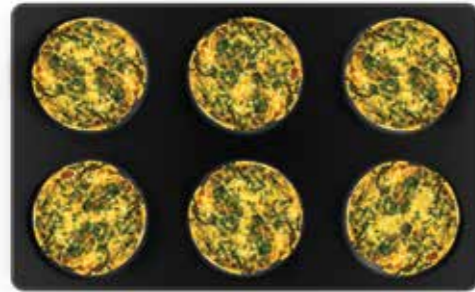

### Ideal for

Fried eggs;  
Sunny side up eggs;  
Omelette.

### Advantages

Huge quantities of eggs cooked  
in less than 4 minutes;  
Easy to clean and made to last.

Art. TG935 GN 1/1

## EGGS 8 x 1

8 single-eggs non-stick alluminum pan.



### Ideal for

Fried eggs;  
Sunny side up eggs and omelette;  
Poached egg.

### Advantages

Huge quantities of fried or poached eggs in  
less than 4 minutes;  
Easy to clean and made to last.

Art. TG936 GN 1/1 - Art. TG937 GN 2/3

## STEAM

Stainless steel steaming pan.

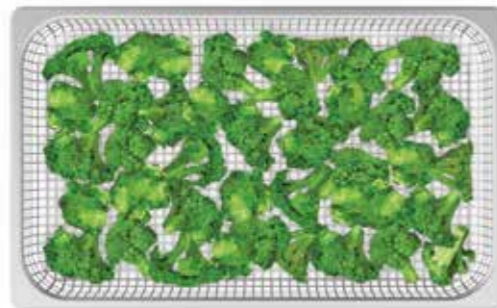

### Ideal for

Steaming;  
Sous-Vide Cooking.

### Advantages

Perforated bottom and sides to improve steam  
circulation on food.

Art. GRP815 GN 1/1 - Art. GRP710 GN 2/3

## FORO.STEEL20

Perforated stainless steel pan.

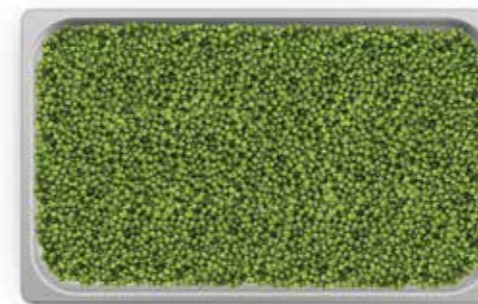

### Ideal for

Steaming;  
Sous-Vide Cooking.

### Advantages

Perforated bottom to improve steam  
circulation on food.

Art. TG810 GN 1/1 - Art. TG710 GN 2/3

## FORO.BLACK

Non-stick perforated alluminum tray.



### Ideal for

Croissant;  
Frozen bread,  
Pastry.

### Advantages

Non-stick coating;  
Ultra-low sides to improve air circulation  
on each piece.

Art. TG890 GN 1/1 - Art. TG730 GN 2/3

## FORO.SILICO

Silicon-coated perforated alluminum pan.



### Ideal for

Croissant;  
Frozen bread;  
Pastry.

### Advantages

Perforated silicon-coated alluminum pan;  
High-temperature resistant;  
Ideal to be used with sugar coated pastries.

Art. TG975 GN 1/1



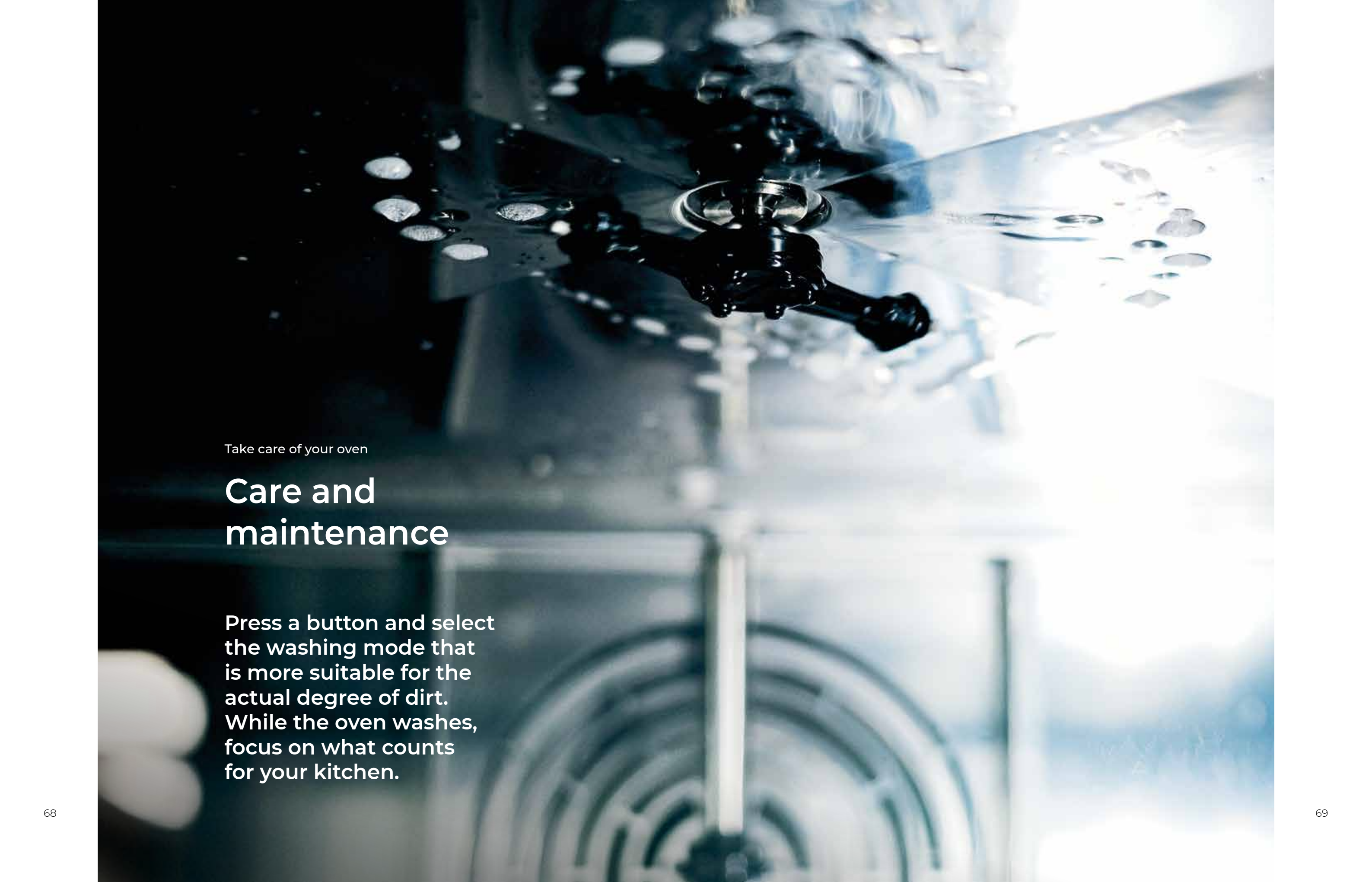

Take care of your oven

## Care and maintenance

Press a button and select the washing mode that is more suitable for the actual degree of dirt. While the oven washes, focus on what counts for your kitchen.

# UNOX.Pure

# DET&Rinse™

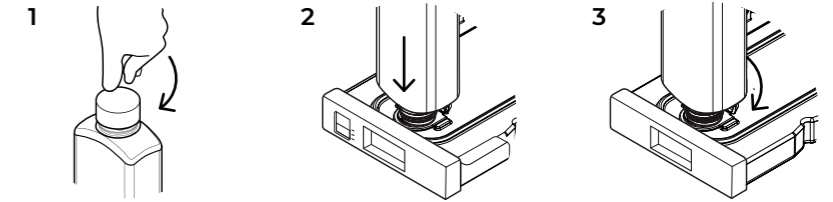

## PURE-RO

Reverse osmosis system that complete eliminates Chlorides and limescale from water.

Art. XHC002  
Technical details at page 83

Not required for CHEFTOP MIND.Maps™ BIG ovens.



## PURE

The UNOX.Pure filter reduces the carbonate hardness in water, thus avoiding scale deposits inside the oven cooking chamber.

Art. XHC003  
Technical details at page 83



## REFILL

Replacement cartridge for UNOX.Pure.

Art. XHC004  
Technical details at page 83



## PLUS

Cleaning and rinse agents to combine maximum cleanliness with minimum consumption and long life for your oven.

Art. DB1015  
Technical details at page 83



## ECO

Eco formula for daily cleaning and the utmost respect for the environment. Ideal for mild level of dirt.

Art. DB1018  
Technical details at page 83



## ULTRA

Ultra strong detergent for high level of dirt, recommended for poultry and meat fats.

Art. DB1050\*  
Technical details at page 83

\*Check the product availability for your Country.



Discover all the ovens and their combined accessories

# The most intelligent oven in the world

## COMPACT

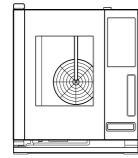

535 x 662 x 649 mm  
w x d x h

### ⚡ XECC - 0523 - EPRM

capacity 5 GN 2/3  
pitch 67 mm  
frequency 50/60 Hz  
voltage 230 V ~ 1N  
400 V ~ 3N  
power 5,2 kW  
weight 57 kg

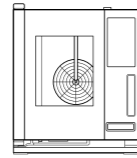

535 x 862 x 649 mm  
w x d x h

### ⚡ XECC - 0513 - EPRM

capacity 5 GN 1/1  
pitch 67 mm  
frequency 50/60 Hz  
voltage 400 V ~ 3N  
power 9,2 kW  
weight 68 kg

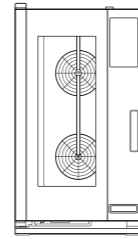

535 x 862 x 984 mm  
w x d x h

### ⚡ XECC - 1013 - EPRM

capacity 10 GN 1/1  
pitch 67 mm  
frequency 50/60 Hz  
voltage 400 V ~ 3N  
power 18,5 kW  
weight 94 kg

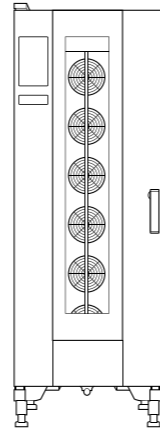

650 x 1002 x 1875 mm  
w x d x h

### ⚡ XECL - 2013 - YPRS

capacity 20 GN 1/1  
pitch 67 mm  
frequency 50/60 Hz  
voltage 380-415V 3N~  
power 38,5 kW  
weight 296 kg

## COUNTERTOP GN 2/1

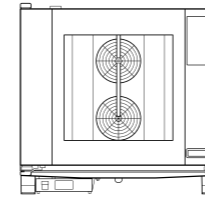

860 x 1145 x 843 mm  
w x d x h

### ⚡ XEVC - 0621 - EPRM

capacity 6 GN 2/1  
pitch 77 mm  
frequency 50/60 Hz  
voltage 400 V ~ 3N  
power 20,5 kW  
weight 119 kg

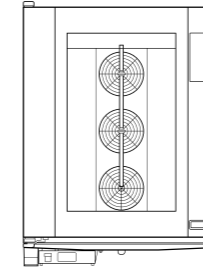

860 x 1145 x 1163 mm  
w x d x h

### ⚡ XEVC - 1021 - EPRM

capacity 10 GN 2/1  
pitch 77 mm  
frequency 50/60 Hz  
voltage 400 V ~ 3N  
power 30,8 kW  
weight 170 kg

### 🔥 XEVC - 0621 - GPRM

capacity 6 GN 2/1  
pitch 77 mm  
frequency 50/60 Hz  
voltage 230 V ~ 1N  
power 1 kW  
max. gas 25 kW  
rated power  
weight 155 kg

### 🔥 XEVC - 1021 - GPRM

capacity 10 GN 2/1  
pitch 77 mm  
frequency 50/60 Hz  
voltage 230 V ~ 1N  
power 1,4 kW  
max. gas 35 kW  
rated power  
weight 183 kg

## BIG

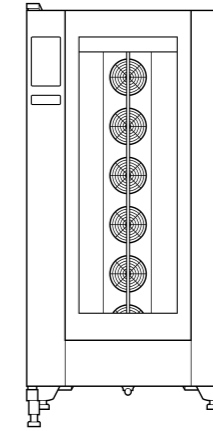

892 x 1018 x 1875 mm  
w x d x h

### ⚡ XEVL - 2011 - YPRS

capacity 20 GN 1/1  
pitch 67 mm  
frequency 50/60 Hz  
voltage 380-415 V  
3PH+N+PE  
power 38,5 kW  
weight 292 kg

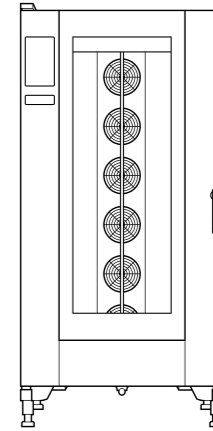

892 x 1257 x 1875 mm  
w x d x h

### ⚡ XEVL - 2021 - YPRS

capacity 20 GN 2/1  
pitch 67 mm  
frequency 50 Hz  
voltage 380-415 V  
3PH+N+PE  
power 65 kW  
weight 339 kg

### ⚡ XEVL - 2011 - DPRS

capacity 20 GN 1/1  
pitch 67 mm  
frequency 50/60 Hz  
voltage 220-240V  
3PH+PE  
power 38,5 kW  
weight 292 kg

### ⚡ XEVL - 2021 - DPRS

capacity 20 GN 2/1  
pitch 67 mm  
frequency 50 Hz  
voltage 220-240V  
3PH+PE  
power 65 kW  
weight 339 kg

### 🔥 XEVL - 2011 - GPRS

capacity 20 GN 1/1  
pitch 67 mm  
frequency 50/60 Hz  
voltage 220-240 V  
1PH+N+PE  
power 2,8 kW  
max. gas 48 kW  
rated power  
weight 309 kg

### 🔥 XEVL - 2021 - GPRS

capacity 20 GN 2/1  
pitch 67 mm  
frequency 50/60 Hz  
voltage 220-240V  
1PH+N+PE  
power 2,5 kW  
max. gas 90 kW  
rated power  
weight 356 kg

## COUNTERTOP GN 1/1

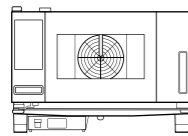

750 x 783 x 538 mm  
w x d x h

### ⚡ XEVC - 0311 - EPRM

capacity 3 GN 1/1  
pitch 67 mm  
frequency 50/60 Hz  
voltage 230 V ~ 1N  
400 V ~ 3N  
power 5 kW  
weight 56 kg

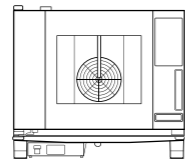

750 x 783 x 675 mm  
w x d x h

### ⚡ XEVC - 0511 - EPRM

capacity 5 GN 1/1  
pitch 67 mm  
frequency 50/60 Hz  
voltage 400 V ~ 3N  
power 9,3 kW  
weight 67 kg

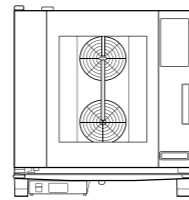

750 x 783 x 843 mm  
w x d x h

### ⚡ XEVC - 0711 - EPRM

capacity 7 GN 1/1  
pitch 67 mm  
frequency 50/60 Hz  
voltage 400 V ~ 3N  
power 11,7 kW  
weight 85 kg

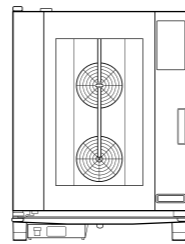

750 x 783 x 1010 mm  
w x d x h

### ⚡ XEVC - 1011 - EPRM

capacity 10 GN 1/1  
pitch 67 mm  
frequency 50/60 Hz  
voltage 400 V ~ 3N  
power 18,5 kW  
weight 98 kg

### 🔥 XEVC - 0511 - GPRM

capacity 5 GN 1/1  
pitch 67 mm  
frequency 50/60 Hz  
voltage 230 V ~ 1N  
power 0,6 kW  
max. gas 15 kW  
rated power  
weight 83 kg

### 🔥 XEVC - 0711 - GPRM

capacity 7 GN 1/1  
pitch 67 mm  
frequency 50/60 Hz  
voltage 230 V ~ 1N  
power 1 kW  
max. gas 19 kW  
rated power  
weight 104 kg

### 🔥 XEVC - 1011 - GPRM

capacity 10 GN 1/1  
pitch 67 mm  
frequency 50/60 Hz  
voltage 230 V ~ 1N  
power 1 kW  
max. gas 22 kW  
rated power  
weight 116 kg

#### Notes

All ovens have an optional model with a left to right door opening - item code example XEVC-1011-EPLM.  
One shelf of the GN 2/1 ovens can contain up to 2 GN 1/1 trays.  
All BIG ovens have the trolley included.



# Technical details



Anti condensation drip tray



Integrated Wi-Fi



Triple glass



Integrated DET&Rinse™ tank



MULTI.point and SOUS Vide core probe



Integrated LED light

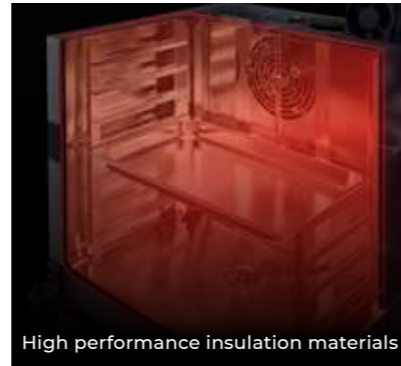

High performance insulation materials



4 speed multiple fan system with high performance heating elements



Stainless steel AISI 304 cooking chamber



Pressure burners with symmetrical heat exchangers

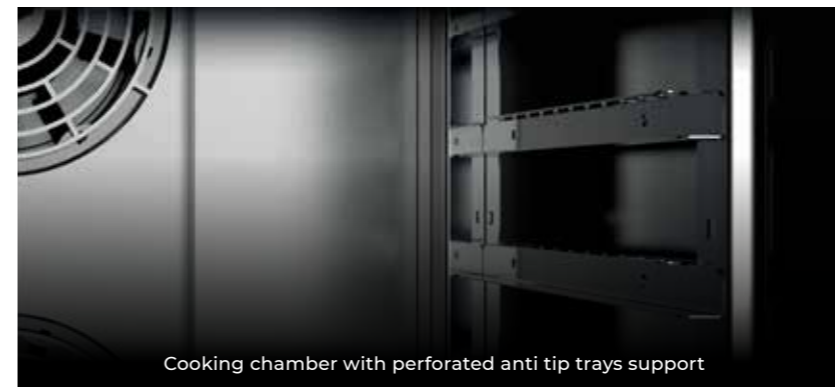

Cooking chamber with perforated anti tip trays support



Door docking position at 60°/120°/180°



USB port for upload/download of data



Ergonomic handle

# Technical details

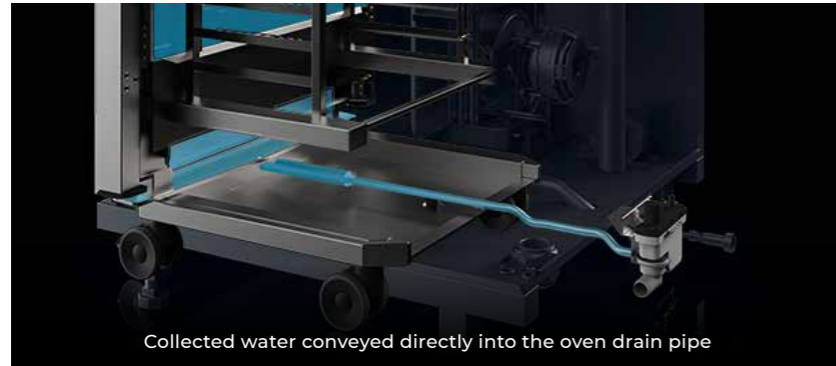

Collected water conveyed directly into the oven drain pipe



Integrated Wi-Fi



Cooking chamber made of highly corrosion-resistant AISI 316L steel.



Space-frame chassis made of 50 mm thick stainless steel tubes.



USB port for upload/download of data



MULTI.point and SOUS Vide core probe



Integrated LED light

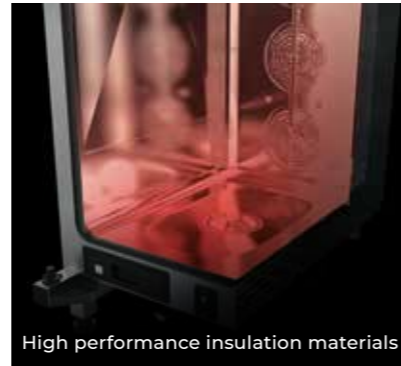

High performance insulation materials

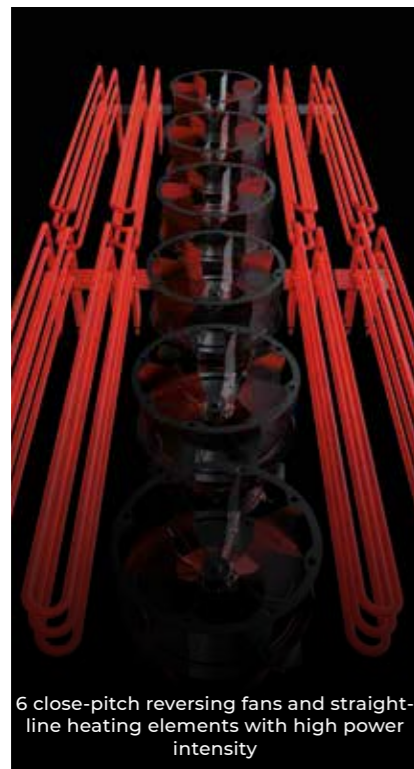

6 close-pitch reversing fans and straight-line heating elements with high power intensity



Push-to-close system with safety latch.



High-performance pressure burners with symmetrical heat exchangers

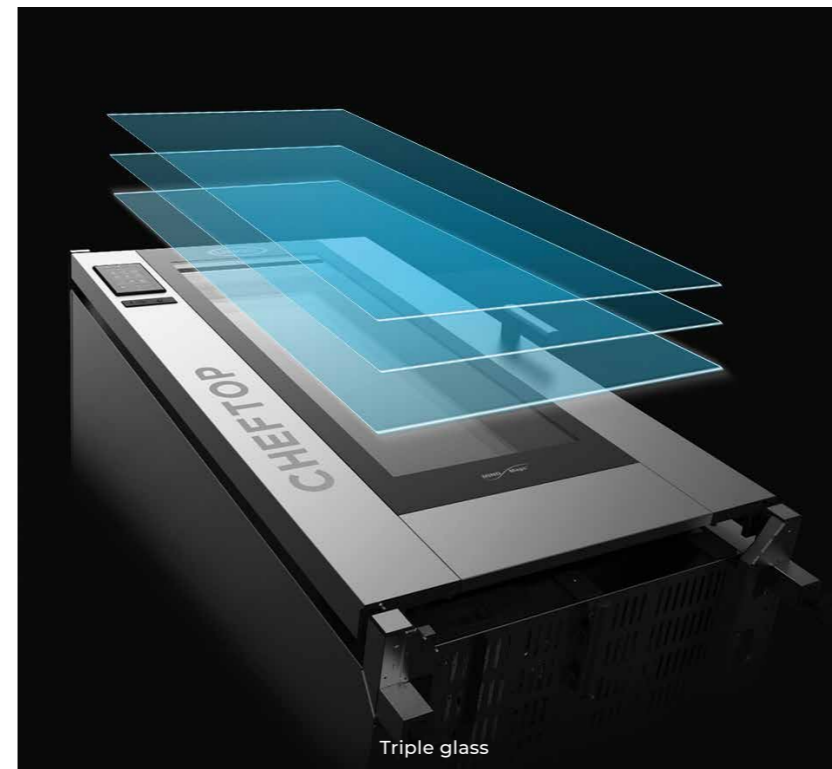

Triple glass

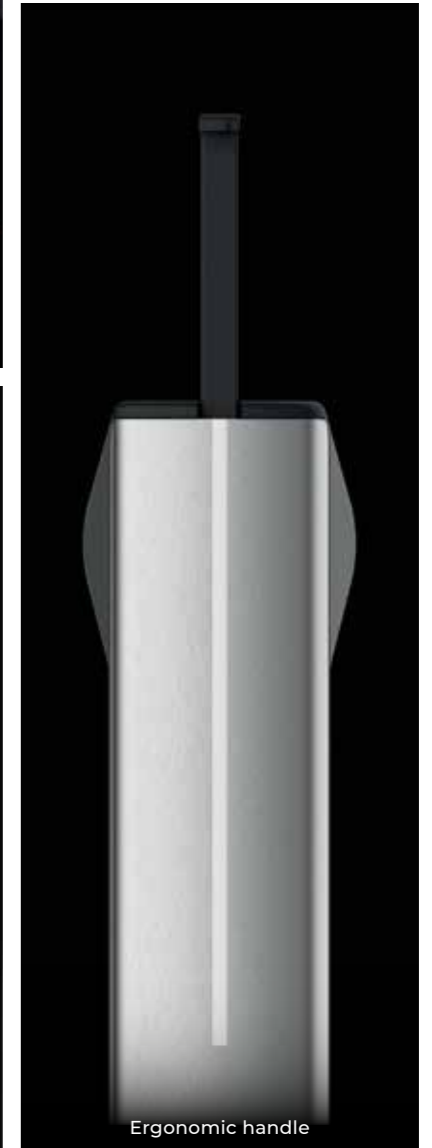

Ergonomic handle



# Features

- Standard
- Optional
- Not available

BIG and BIG COMPACT  
COUNTERTOP and COMPACT

	BIG and BIG COMPACT	COUNTERTOP and COMPACT
<b>UNOX INTELLIGENT PERFORMANCE</b>		
ADAPTIVE.Cooking™: automatically regulates the cooking parameters to ensure repeatable results	● ●	● ●
CLIMALUX™: total control of the humidity in the cooking chamber	● ●	● ●
SMART.Preheating: sets automatically the temperature and the duration of the preheating	● ●	● ●
AUTO.Soft: manages the heat rise to make it more delicate	● ●	● ●
SENSE.Klean: estimates how dirty the oven is and suggests appropriate automatic cleaning	● ●	● ●
<b>UNOX INTENSIVE COOKING</b>		
DRY.Maxi™: rapidly extracts the humidity from the cooking chamber	● ●	● ●
STEAM.Maxi™: produces saturated steam starting from 35 °C	● ●	● ●
AIR.Maxi™: multiple fans with reverse gear and 4 speed settings	● ●	● ●
EFFICIENT.Power: ENERGY STAR certified energy efficiency	● ●	● ●
PRESSURE.Steam: increases the saturation and temperature of steam	● ●	● ●
<b>DATA DRIVEN COOKING</b>		
Wi-Fi connection	● ●	● ●
Ethernet connection	○ ○	○ ○
ddc.unox.com: control the oven usage in real time, create and send recipes from your PC to your ovens	● ●	● ●
DDC.Stats: analyse, compare and improve the user and consumption data of your oven	● ●	● ●
DDC.App: monitor all connected ovens in real time from your smartphone	● ●	● ●
DDC.Coach: analyses the way in which you use the oven and suggests personalised recipes	● ●	● ●
<b>MANUAL COOKING</b>		
Convection cooking from 30 °C to 260 °C	● ●	● ●
Convection cooking from 30 °C to 300 °C	● ●	— —
Mixed convection + steam cooking starting from 35 °C with STEAM.Maxi™ from 30% to 90%	● ●	● ●
Convection + humidity cooking starting from 48 °C with STEAM.Maxi™ from 10% to 20%	● ●	● ●
Saturated steam cooking starting from 48 °C to 130 °C with STEAM.Maxi™ 100%	● ●	● ●
Convection cooking + forced humidity extraction from 30 °C with DRY.Maxi™ from 10% to 100%	● ●	● ●
Cooking with core probe and DELTA T function	● ●	● ●
Single-point core probe	— —	— —
MULTI.Point core probe - excluding models XEVC-0311-EPRM / XECC-0523-EPRM	● ●	● ●
SOUS-VIDE core probe	○ ○	○ ○
<b>ADVANCED AND AUTOMATIC COOKING</b>		
MIND.Maps™: draw the cooking processes directly on the display	● ●	● ●
PROGRAMMES: up to 384 programmes that can be saved with name, picture or handwritten signature	● ●	● ●
CHEFUNOX: choose something to cook from the library and the oven will automatically set all the parameters	● ●	● ●
MULTI.Time: manages up to 10 cooking processes at the same time	● ●	● ●
MISE.EN.PLACE: synchronises the insertion of pans so that all the dishes are ready at the same time	● ●	● ●
<b>AUTOMATIC CLEANING</b>		
Rotor.KLEAN™: 4 automatic cleaning programmes	● ●	● ●
Rotor.KLEAN™: water and detergent level detector – excluding models XEVC-0311-EPRM / XECC-0523-EPRM	● ●	● ●
Integrated DET&Rinse™ detergent container	● ●	● ●
<b>AUXILIARY FUNCTIONS</b>		
Preheating up to 300 °C can be set by the user for each programme	● ●	— —
Preheating up to 260 °C can be set by the user for each programme	● ●	● ●
Remaining cooking time display	● ●	● ●
Holding cooking mode "HOLD" and continuous functioning "INF"	● ●	● ●
Display of the nominal value of the cooking parameters	● ●	● ●
Temperature units in °C or °F	● ●	● ●
<b>PERFORMANCE AND SAFETY</b>		
Protek.SAFE™: automatic fan stop on opening the door	● ●	● ●
Protek.SAFE™: power modulation of electricity or gas depending on actual need	● ●	● ●
Spido.GAS™: high-performance straight heat exchanger pipes for symmetrical heat distribution	— —	● ●
Spido.GAS™: high-performance pressure burners and symmetrical exchangers	— ●	— —
<b>TECHNICAL DETAILS</b>		
Cooking chamber in high-resistance AISI 304 stainless steel with rounded edges	— —	● ●
Moulded cooking chamber in AISI 316 L marine stainless steel	● ●	— —
Cooking chamber with C-shaped rack rails	● ●	● ●
Cooking chamber lighting through LED lights embedded in the door	● ●	● ●
9.5" touchscreen capacitive control panel	● ●	● ●
7" touchscreen resistive control panel	— —	— —
Control panel with water resistance certification - IPX5	● ●	● ●
Drip collection system integrated in the door and functional even with the door open	● ●	● ●
Heavy-duty structure with the use of innovative materials	● ●	● ●
4-speed multiple fan system and high-performance circular resistance	— —	● ●
6 motors with multiple fan system with reverse gear and high power intensity rectilinear resistance	● ●	— —
Door hinges made of high-resistance, self-lubricating techno-polymer	● ●	● ●
Door stop positions 120° - 180°	● ●	— —
Door stop positions 60° - 120° - 180°	— —	● ●
Reversible door in use even after installation	— —	○ ○
Door thickness 70 mm	● ●	— —
Detachable internal glass door for ease of cleaning	● ●	● ●
Two-stage safety door opening / closure	● ●	○ ○
Proximity door contact switch	● ●	● ●
Self-diagnosis system to detect problems or breakdowns	● ●	● ●
Safety temperature switch	● ●	● ●

# Accessories

Discover all the available accessories on our website



## SLOWTOP

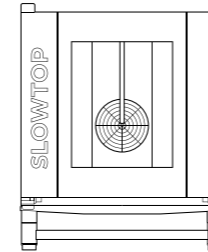

### SLOWTOP

for GN1/1 COUNTERTOP ovens  
750 x 792 x 961 mm - w x d x h  
Art. XEVSC-0711-CRM

## HOODS

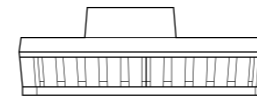

### HOOD WITH ACTIVATED CARBON FILTER

for 10 & 6 GN 2/1 COUNTERTOP ovens  
868 x 1323 x 366 mm - w x d x h  
Art. XEVHC-CF21

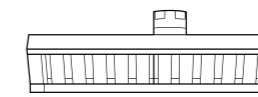

### HOOD WITH STEAM CONDENSER

for 10 & 6 GN 2/1 COUNTERTOP ovens  
868 x 1323 x 240 mm - w x d x h  
Art. XEVHC-HC21

for 20 GN 1/1 BIG ovens  
892 x 1131 x 342 mm - w x d x h  
Art. XEAHL-HCFL

for 20 GN 1/1 BIG COMPACT ovens  
650 x 1208 x 240 mm - w x d x h  
Art. XECHL-HCFC

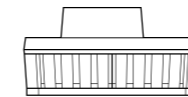

### HOOD WITH ACTIVATED CARBON FILTER

for GN 1/1 COUNTERTOP ovens  
750 x 956 x 366 mm - w x d x h  
Art. XEVHC-CF11

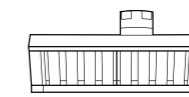

### HOOD WITH STEAM CONDENSER

for GN 1/1 COUNTERTOP ovens  
750 x 956 x 240 mm - w x d x h  
Art. XEVHC-HC11

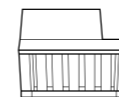

### HOOD WITH ACTIVATED CARBON FILTER

for GN 1/1 COMPACT ovens  
535 x 1018 x 366 mm - w x d x h  
Art. XEHC-CF13

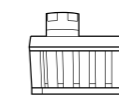

### HOOD WITH STEAM CONDENSER

for GN 1/1 COMPACT ovens  
535 x 1100 x 240 mm - w x d x h  
Art. XEHC-HC13

for GN 2/3 COMPACT ovens  
535 x 900 x 240 mm - w x d x h  
Art. XEHC-HC23

## NEUTRAL CABINET

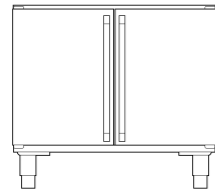

### NEUTRAL CABINET

for GN 2/1 COUNTERTOP ovens  
860 x 1079 x 717 mm - w x d x h  
**Art. XWVEC-0821**

for GN 1/1 COUNTERTOP ovens  
750 x 656 x 676 mm - w x d x h  
**Art. XWVEC-0811**

## STAND

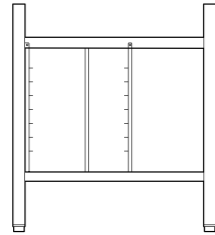

### ULTRA HIGH STAND

for GN 1/1 COUNTERTOP ovens  
732 x 641 x 888 mm - w x d x h  
**Art. XWVRC-0711-UH**

### HIGH STAND

for GN 2/1 COUNTERTOP ovens  
842 x 864 x 692 mm - w x d x h  
**Art. XWVRC-0721-H**

for GN 1/1 COUNTERTOP ovens  
732 x 546 x 752 mm - w x d x h  
**Art. XWVRC-07 11-H**

for GN 1/1 COMPACT ovens  
518 x 779 x 744 mm - w x d x h  
**Art. XWCRC-0613-H**

for GN 2/3 COMPACT ovens  
518 x 585 x 744 mm - w x d x h  
**Art. XWCRC-0623-H**

### INTERMEDIATE STAND

for GN 1/1 COUNTERTOP ovens  
732 x 546 x 462 mm - w x d x h  
**Art. XWVRC-0011-M**

### LOW STAND

for GN 2/1 COUNTERTOP ovens  
842 x 891 x 305 mm - w x d x h  
**Art. XWVRC-0021-L**

for GN 1/1 COUNTERTOP ovens  
732 x 546 x 305 mm - w x d x h  
**Art. XWVRC-0011-L**

for GN 1/1 COMPACT ovens  
518 x 684 x 305 mm - w x d x h  
**Art. XWCRC-0013-L**

for GN 2/3 COMPACT ovens  
518 x 484 x 305 mm - w x d x h  
**Art. XWCRC-0023-L**

## HYPER.SMOKER



### HYPER.SMOKER

for CHEFTOP MIND.Maps™ PLUS ovens - Check the compatibility with models that have been produced before 2016  
**Art. XUC090**

## FLOOR POSITIONING STAND

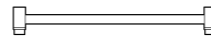

\*Mandatory for oven positioning on the floor

### FLOOR POSITIONING STAND

for GN 2/1 COUNTERTOP ovens  
842 x 891 x 113 mm - w x d x h  
**Art. XWVRC-0021-F**

for GN 1/1 COUNTERTOP ovens  
732 x 546 x 113 mm - w x d x h  
**Art. XWVRC-0011-F**

for GN 1/1 COMPACT ovens  
732 x 479 x 113 mm - w x d x h  
**Art. XECRC-0013-F**

## BASKETS AND TROLLEYS

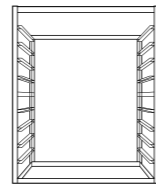

### BASKET

for 10 GN 2/1 COUNTERTOP ovens  
622 x 674 x 865 mm - w x d x h  
**Art. XWVBC-1021**

for 10 GN 1/1 COUNTERTOP ovens  
568 x 361 x 713 mm - w x d x h  
**Art. XWVBC-0911**

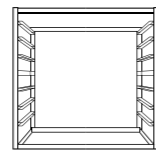

### BASKET

for 6 GN 2/1 COUNTERTOP ovens  
622 x 674 x 545 mm - w x d x h  
**Art. XWVBC-0621**

for 7 GN 1/1 COUNTERTOP ovens  
568 x 361 x 546 mm - w x d x h  
**Art. XWVBC-0611**

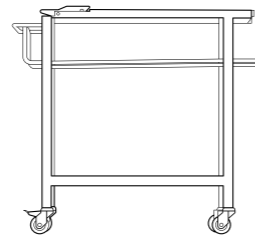

### TROLLEY

for GN 2/1 baskets  
647 x 855 x 923 mm - w x d x h  
**Art. XWVYC-0021**

for GN 1/1 baskets  
605 x 700 x 923 mm - w x d x h  
**Art. XWVYC-0011**

## WHEELS KIT

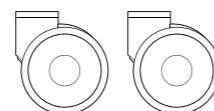

### WHEELS KIT

2 wheels with brake - 2 wheels without brake - safety chains  
**Art. XUC012**

## QUICK.LOAD & QUICK.PLATE

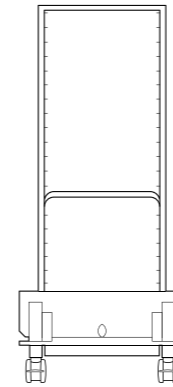

### QUICK.LOAD

for 20 GN 2/1 BIG ovens  
776 x 851 x 1741 mm - w x d x h  
**Art. XEVTL-2021**

for 20 GN 1/1 BIG ovens  
776 x 681 x 1741 mm - w x d x h  
**Art. XEVTL-2011**

for 20 GN 1/1 BIG COMPACT ovens  
520 x 668 x 1745 mm - w x d x h  
**Art. XECTL-2013**

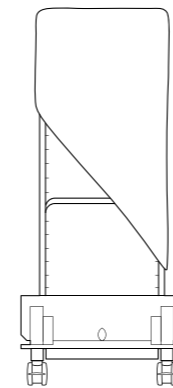

### HOLDING.COVER

thermocover

for QUICK.LOAD and QUICK.PLATE GN 2/1  
**Art. XUC031**

for QUICK.LOAD and QUICK.PLATE GN 1/1  
**Art. XUC030**

for QUICK.LOAD and QUICK.PLATE BIG COMPACT  
**Art. XUC033**

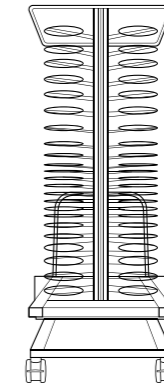

### QUICK.PLATE

for 20 GN 2/1 BIG ovens  
- 102 plates  
776 x 851 x 1709 mm - w x d x h  
**Art. XEVTL-102P**

for 20 GN 1/1 BIG ovens  
- 51 plates  
776 x 681 x 1709 mm - w x d x h  
**Art. XEVTL-051P**

for 20 GN 1/1 BIG COMPACT ovens  
- 34 plates  
520 x 668 x 1711 mm - w x d x h  
**Art. XECTL-034P**

for 20 GN 1/1 BIG COMPACT ovens  
- 51 plates  
520 x 668 x 1711 mm - w x d x h  
**Art. XECTL-051P**

## SMART.DRAIN

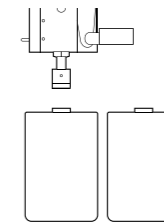

### SMART.DRAIN

cooking fat and liquid collection system

for neutral cabinet and high open stand  
**Art. XUC020**

\*for all the solutions see page 40



### STAND

for GN 1/1 COUNTERTOP ovens  
732 x 546 x 305 mm - w x d x h  
**Art. XWVRC-0011-L-PO**

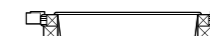

### TROLLEY

for GN 1/1 COUNTERTOP ovens  
629 x 708 x 106 mm - w x d x h  
**Art. XWVYC-0011-L-PO**

## CARE AND MAINTENANCE

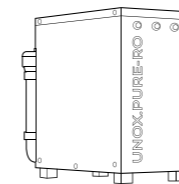

### UNOX.PURE-RO

reverse osmosis filtering system  
**Art. XHC002**

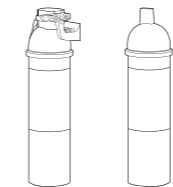

### UNOX.PURE

water treatment with resin filters  
**Art. XHC003**

+ REFILL FILTER CARTRIDGE  
**Art. XHC004**

## OVEN CLEANING PRODUCTS



### DET&RINSE™ PLUS DET&RINSE™ ECO DET&RINSE™ ULTRA

one box contains 10 x 1 lt tanks  
**Art. DB1015**  
**Art. DB1018**  
**Art. DB1050**

## CONNECTIVITY

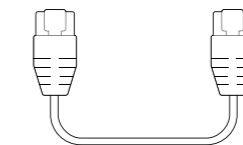

### ACCESSORIES FOR THE OVENS CONNECTION

Ethernet connection kit  
**Art. XEC001**



# Technical Assistance

## Installation

### The right partner next to your kitchen

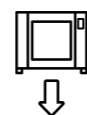

#### A global Service network

A perfect installation is essential to guarantee the correct functioning of your MIND.Maps™ PLUS oven and eliminate interruptions in your daily work. We focus on you, so you can focus on what matters to you. Find the authorized Service Centers nearest to your kitchen.

## Maintenance

### Don't stop your kitchen



#### The quickest on site Service

When connected to the internet, your oven communicates directly with our Service Team, so we can intervene as soon or even before maintenance is required. Keeping in optimal condition your oven is Unox' priority: our technicians are at your disposal to provide you the best on-line and on-site support.

## LONG.Life and LONG.Life4 Warranty

### A promise of reliability



#### A choice made to last

Connect your CHEFTOP MIND.Maps™ PLUS to the internet and activate the UNOX LONG.Life4 extended warranty on our website unox.com. Up to 4 years / 10.000 working hours, whichever occurs first, on parts and 2 years on labor.\*

\*Check the Guarantee Conditions for your country on our website unox.com

## **LONG**Life4!

Global Company. Best Services worldwide.

# UNOX in the world

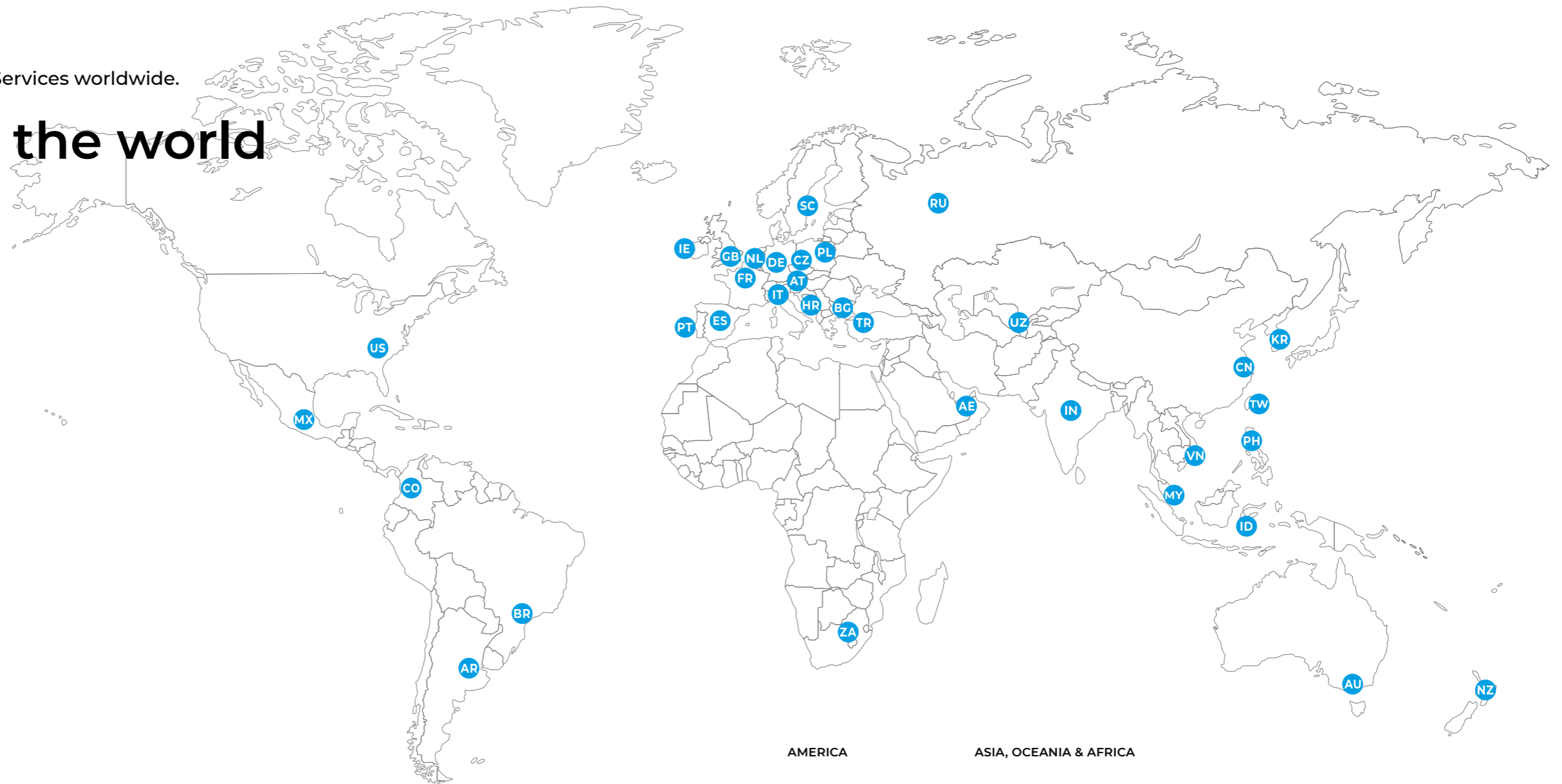

Contacts

## INTERNAZIONALE

### UNOX S.p.a

Via Majorana, 22  
35010 - Cadoneghe (PD) - Italy  
E-mail: info@unox.com  
Tel: +39 049 8657511

## EUROPE

### IT - ITALIA UNOX S.p.a

E-mail: info@unox.it  
Tel: +39 049 736 0781

### DE - DEUTSCHLAND UNOX DEUTSCHLAND GMBH

E-mail: info.de@unox.com  
Tel: +49 32 211121581

### FR - FRANCE, BELGIUM & LUXEMBOURG UNOX FRANCE S.a.s.

E-mail: info.fr@unox.com  
Tel: +33 4 81 68 19 12

### PT - PORTUGAL UNOX PORTUGAL

E-mail: info.pt@unox.com  
Tel: +351 918 228 787

### ES - ESPAÑA UNOX PROFESIONAL ESPAÑA S.L.

E-mail: info.es@unox.com  
Tel: +34 932 20 36 52

### GB - UNITED KINGDOM UNOX UK Ltd.

E-mail: info.uk@unox.com  
Tel: +44 1252 851 522

### IE - IRELAND UNOX IRELAND

E-mail: info.ie@unox.com  
Tel: +353 (0) 87 32 23 218

### SC - SCANDINAVIAN COUNTRIES UNOX SCANDINAVIA AB

E-mail: info.se@unox.com  
Tel: +46(0)790 75 63 64

### AT - ÖSTERREICH UNOX ÖSTERREICH GMBH

E-mail: info.de@unox.com  
Tel: +43 1206 092 068

### RU - РОССИЯ, ПРИБАЛТИКА И СТРАНЫ СНГ UNOX РОССИЯ

E-mail: info.ru@unox.com  
Tel: +7 (499) 702 - 00 - 14

### CZ - ČESKÁ REPUBLIKA UNOX DISTRIBUTION s.r.o.

E-mail: info.cz@unox.com  
Tel: +420 241 940 000

### HR - HRVATSKA UNOX CROATIA

E-mail: narudzbe@unox.com  
Tel: +39 049 86 57 538

### BG - БЪЛГАРИЯ UNOX BULGARIA

E-mail: info.bg@unox.com  
Tel: +359 2 419 05 00

### PL - POLSKA Unox Polska Sp.oz.o.

E-mail: info.pl@unox.com  
Tel: + 48 22 104 17 01

### TR - TÜRKİYE - UNOX TURKEY Profesyonel mutfak ekipmanlari endüstri ve ticaret limited şirketi

E-mail: info.tr@unox.com  
Tel: +90 530 176 62 03

### NL - NETHERLANDS UNOX NETHERLANDS B.V.

E-mail: info.nl@unox.com  
Tel: +31 70 700 6170

## AMERICA

### US - U.S.A. & CANADA UNOX Inc.

E-mail: info.usa@unox.com  
Tel: +1 800 489 8669

### CO - COLOMBIA UNOX COLOMBIA

E-mail: info.co@unox.com  
Tel: +57 350 65 88 204

### BR - BRASIL UNOX BRASIL SERVICOS LTDA.

E-mail: info.br@unox.com  
Tel: +55 11 98717-8201

### AR - ARGENTINA UNOX ARGENTINA

E-mail: info.ar@unox.com  
Tel: +54 911 37 58 43 46

### MX - MEXICO, S. DE R.L. DE C.V.

E-mail: info.mx@unox.com  
Tel: +52 55 8116-7720

## ASIA, OCEANIA & AFRICA

### ZA - SOUTH AFRICA UNOX SOUTH AFRICA

E-mail: info.za@unox.com  
Tel: +27 845 05 52 35

### AE - U.A.E. UNOX MIDDLE EAST DMCC

E-mail: info.uae@unox.com  
Tel: +971 4 554 2146

### UZ - UZBEKISTAN UNOX PRO LLC

E-mail: info.uz@unox.com  
Tel: +998 90 370 90 10

### CN - 中华人民共和国 UNOX TRADING(SHANGHAI) Ltd. CO.

E-mail: info.china@unox.com  
Tel: +86 21 56907696

### MY - MALAYSIA & SINGAPORE UNOX (ASIA) SDN. BHD

E-mail: info.asia@unox.com  
Tel: +603-58797700

### PH - PHILIPPINES UNOX PHILIPPINES

E-mail: Order.Asia@unox.com  
Tel: +63 9173108084

### ID - INDONESIA UNOX INDONESIA

E-mail: Order.Asia@unox.com  
Tel: +62 81908852999

### KR - 대한민국 UNOX KOREA CO. Ltd.

E-mail: info.kr@unox.com  
Tel: +82 2 69410351

### TW - TAIWAN, HONG KONG & MACAU UNOX TAIWAN

E-mail: info.tw@unox.com  
Tel: +886 928 250 536

### AC - OTHER ASIAN COUNTRIES UNOX (ASIA) SDN. BHD

E-mail: info.asia@unox.com  
Tel: +603-58797700

### AU - AUSTRALIA UNOX AUSTRALIA PTY Ltd.

E-mail: info@unoxaustralia.com.au  
Tel: +61 3 9876 0803

### NZ - NEW ZEALAND UNOX NEW ZEALAND Ltd.

E-mail: info@unox.co.nz  
Tel: +64 (0) 800 76 0803

### IN - INDIA UNOX INDIA PRIVATE LIMITED

E-mail: info.in@unox.com  
Tel: +971 4 554 2146

### VN - VIETNAM UNOX INDOCHINA

E-mail: info.asia@unox.com  
Tel: +84916560803

Contacts

MIND.Maps™ PLUS

MIND.Maps™ PLUS





INVENTIVE SIMPLIFICATION

[unox.com](http://unox.com)



L11387B1 printed on 07-2021

All images used are for illustrative purposes only.

All features indicated in this catalogue may be subject to change and could be updated without notice.